

## ADXL103/ADXL203

### FEATURES

- High performance, single-/dual-axis accelerometer on a single IC chip
- 5 mm × 5 mm × 2 mm LCC package
- 1 mg resolution at 60 Hz
- Low power: 700  $\mu A$  at  $V_S = 5 V$  (typical)
- High zero  $g$  bias stability
- High sensitivity accuracy
- 40°C to +125°C temperature range
- X and Y axes aligned to within 0.1° (typical)
- BW adjustment with a single capacitor
- Single-supply operation
- 3500  $g$  shock survival
- RoHS-compliant
- Compatible with Sn/Pb- and Pb-free solder processes
- Qualified for automotive applications

### APPLICATIONS

- Vehicle dynamic control (VDC)/electronic stability program (ESP) systems
- Electronic chassis control
- Electronic braking
- Platform stabilization/leveling
- Navigation
- Alarms and motion detectors
- High accuracy, 2-axis tilt sensing

### GENERAL DESCRIPTION

The ADXL103/ADXL203 are high precision, low power, complete single- and dual-axis accelerometers with signal conditioned voltage outputs, all on a single, monolithic IC. The ADXL103/ADXL203 measure acceleration with a full-scale range of  $\pm 1.7 g$ . The ADXL103/ADXL203 can measure both dynamic acceleration (for example, vibration) and static acceleration (for example, gravity).

The typical noise floor is 110  $\mu g/\sqrt{Hz}$ , allowing signals below 1 mg (0.06° of inclination) to be resolved in tilt sensing applications using narrow bandwidths (<60 Hz).

The user selects the bandwidth of the accelerometer using Capacitor  $C_X$  and Capacitor  $C_Y$  at the  $X_{OUT}$  and  $Y_{OUT}$  pins. Bandwidths of 0.5 Hz to 2.5 kHz may be selected to suit the application.

The ADXL103 and ADXL203 are available in 5 mm × 5 mm × 2 mm, 8-pad hermetic LCC packages.

### FUNCTIONAL BLOCK DIAGRAM

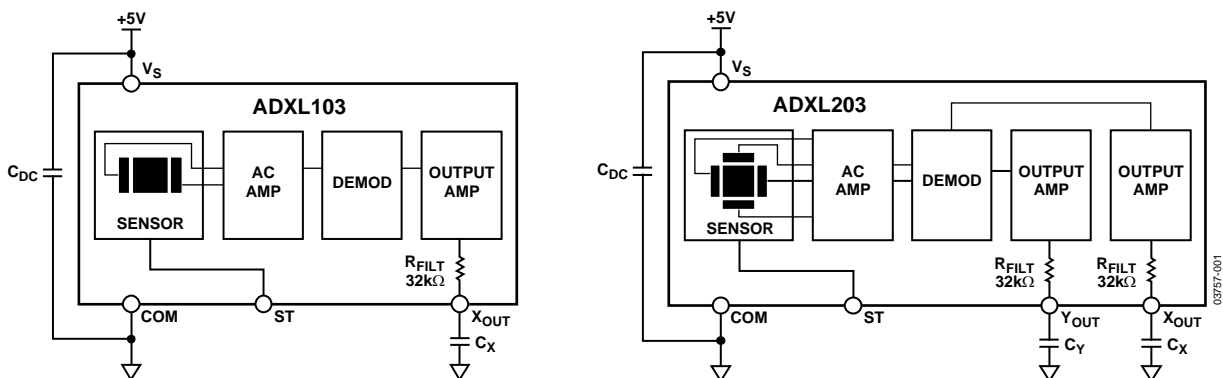

Figure 1.

#### Rev. C

Information furnished by Analog Devices is believed to be accurate and reliable. However, no responsibility is assumed by Analog Devices for its use, nor for any infringements of patents or other rights of third parties that may result from its use. Specifications subject to change without notice. No license is granted by implication or otherwise under any patent or patent rights of Analog Devices. Trademarks and registered trademarks are the property of their respective owners.

## TABLE OF CONTENTS

Features .....	1	Power Supply Decoupling .....	10
Applications .....	1	Setting the Bandwidth Using $C_X$ and $C_Y$ .....	10
General Description .....	1	Self Test .....	10
Specifications .....	3	Design Trade-Offs for Selecting Filter Characteristics: The Noise/BW Trade-Off .....	10
Absolute Maximum Ratings .....	4	Using the ADXL103/ADXL203 with Operating Voltages Other than 5 V .....	11
ESD Caution .....	4	Using the ADXL203 as a Dual-Axis Tilt Sensor .....	11
Pin Configurations and Function Descriptions .....	5	Outline Dimensions .....	12
Typical Performance Characteristics .....	6	Ordering Guide .....	12
Theory of Operation .....	9	Automotive Products .....	12
Performance .....	9		
Applications .....	10		

## REVISION HISTORY

### 5/10—Rev. B to Rev. C

Changes to Figure 24 Caption .....	12
Added Automotive Products Section .....	12

### 4/10—Rev. A to Rev. B

Changes to Features Section .....	1
Updated Outline Dimensions .....	12
Changes to Ordering Guide .....	12

### 2/06—Rev. 0 to Rev. A

Changes to Features .....	1
Changes to Table 1 .....	3
Changes to Figure 2 .....	4
Changes to Figure 3 and Figure 4 .....	5
Changes to the Performance Section .....	9

### 4/04—Revision 0: Initial Version

## SPECIFICATIONS

$T_A = -40^{\circ}\text{C}$  to  $+125^{\circ}\text{C}$ ,  $V_S = 5\text{ V}$ ,  $C_X = C_Y = 0.1\ \mu\text{F}$ , acceleration =  $0\text{ g}$ , unless otherwise noted.

Table 1.

Parameter	Conditions	Min <sup>1</sup>	Typ	Max <sup>1</sup>	Unit
SENSOR INPUT	Each axis				
Measurement Range <sup>2</sup>		$\pm 1.7$			<i>g</i>
Nonlinearity	% of full scale		$\pm 0.2$	$\pm 1.25$	%
Package Alignment Error			$\pm 1$		Degrees
Alignment Error (ADXL203)	X sensor to Y sensor		$\pm 0.1$		Degrees
Cross-Axis Sensitivity			$\pm 1.5$	$\pm 3$	%
SENSITIVITY (RATIOMETRIC) <sup>3</sup>	Each axis				
Sensitivity at $X_{\text{OUT}}$ , $Y_{\text{OUT}}$	$V_S = 5\text{ V}$	960	1000	1040	mV/g
Sensitivity Change Due to Temperature <sup>4</sup>	$V_S = 5\text{ V}$		$\pm 0.3$		%
ZERO <i>g</i> BIAS LEVEL (RATIOMETRIC)	Each axis				
0 <i>g</i> Voltage at $X_{\text{OUT}}$ , $Y_{\text{OUT}}$	$V_S = 5\text{ V}$	2.4	2.5	2.6	V
Initial 0 <i>g</i> Output Deviation from Ideal	$V_S = 5\text{ V}$ , $25^{\circ}\text{C}$		$\pm 25$		mg
0 <i>g</i> Offset vs. Temperature			$\pm 0.1$	$\pm 0.8$	mg/ $^{\circ}\text{C}$
NOISE PERFORMANCE					
Output Noise	<4 kHz, $V_S = 5\text{ V}$		1	3	mV rms
Noise Density			110		$\mu\text{g}/\sqrt{\text{Hz}}$ rms
FREQUENCY RESPONSE <sup>5</sup>					
$C_X$ , $C_Y$ Range <sup>6</sup>		0.002		10	$\mu\text{F}$
$R_{\text{FILT}}$ Tolerance		24	32	40	k $\Omega$
Sensor Resonant Frequency			5.5		kHz
SELF TEST <sup>7</sup>					
Logic Input Low				1	V
Logic Input High		4			V
ST Input Resistance to Ground		30	50		k $\Omega$
Output Change at $X_{\text{OUT}}$ , $Y_{\text{OUT}}$	Self Test 0 to Self Test 1	450	750	1100	mV
OUTPUT AMPLIFIER					
Output Swing Low	No load	0.05	0.2		V
Output Swing High	No load		4.5	4.8	V
POWER SUPPLY					
Operating Voltage Range		3		6	V
Quiescent Supply Current			0.7	1.1	mA
Turn-On Time <sup>8</sup>			20		ms

<sup>1</sup> All minimum and maximum specifications are guaranteed. Typical specifications are not guaranteed.

<sup>2</sup> Guaranteed by measurement of initial offset and sensitivity.

<sup>3</sup> Sensitivity is essentially ratiometric to  $V_S$ . For  $V_S = 4.75\text{ V}$  to  $5.25\text{ V}$ , sensitivity is 186 mV/V/g to 215 mV/V/g.

<sup>4</sup> Defined as the output change from ambient-to-maximum temperature or ambient-to-minimum temperature.

<sup>5</sup> Actual frequency response controlled by user-supplied external capacitor ( $C_X$ ,  $C_Y$ ).

<sup>6</sup> Bandwidth =  $1/(2 \times \pi \times 32\text{ k}\Omega \times C)$ . For  $C_X$ ,  $C_Y = 0.002\ \mu\text{F}$ , bandwidth = 2500 Hz. For  $C_X$ ,  $C_Y = 10\ \mu\text{F}$ , bandwidth = 0.5 Hz. Minimum/maximum values are not tested.

<sup>7</sup> Self-test response changes cubically with  $V_S$ .

<sup>8</sup> Larger values of  $C_X$ ,  $C_Y$  increase turn-on time. Turn-on time is approximately  $160 \times C_X$  or  $C_Y + 4\text{ ms}$ , where  $C_X$ ,  $C_Y$  are in  $\mu\text{F}$ .

# ADXL103/ADXL203

## ABSOLUTE MAXIMUM RATINGS

Table 2.

Parameter	Rating
Acceleration (Any Axis, Unpowered)	3500 g
Acceleration (Any Axis, Powered)	3500 g
Drop Test (Concrete Surface)	1.2 m
$V_s$	-0.3 V to +7.0 V
All Other Pins	(COM - 0.3 V) to ( $V_s + 0.3$ V)
Output Short-Circuit Duration (Any Pin to Common)	Indefinite
Temperature Range (Powered)	-55°C to +125°C
Temperature Range (Storage)	-65°C to +150°C

Stresses above those listed under Absolute Maximum Ratings may cause permanent damage to the device. This is a stress rating only; functional operation of the device at these or any other conditions above those indicated in the operational section of this specification is not implied. Exposure to absolute maximum rating conditions for extended periods may affect device reliability.

Table 3. Package Characteristics

Package Type	$\theta_{JA}$	$\theta_{JC}$	Device Weight
8-Lead CLCC	120°C/W	20°C/W	<1.0 gram

## ESD CAUTION

ESD (electrostatic discharge) sensitive device. Electrostatic charges as high as 4000 V readily accumulate on the human body and test equipment and can discharge without detection. Although this product features proprietary ESD protection circuitry, permanent damage may occur on devices subjected to high energy electrostatic discharges. Therefore, proper ESD precautions are recommended to avoid performance degradation or loss of functionality.

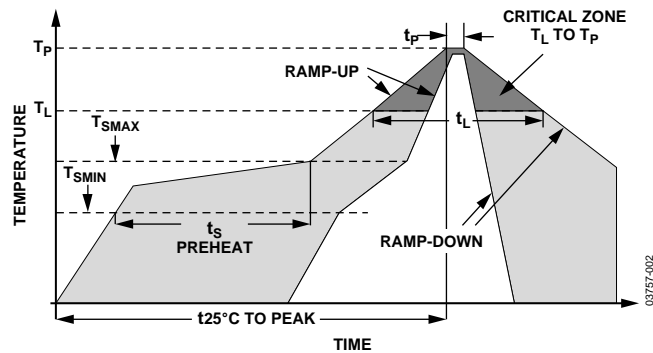

Profile Feature	Condition	
	Sn63/Pb37	Pb-Free
Average Ramp Rate ( $T_L$ to $T_P$ )	3°C/second max	
Preheat		
• Minimum Temperature ( $T_{SMIN}$ )	100°C	150°C
• Maximum Temperature ( $T_{SMAX}$ )	150°C	200°C
• Time ( $T_{SMIN}$ to $T_{SMAX}$ ) ( $t_S$ )	60 to 120 seconds	60 to 150 seconds
$T_{SMAX}$ to $T_L$		
• Ramp-Up Rate	3°C/second	
Time Maintained above Liquidous ( $T_L$ )		
• Liquidous Temperature ( $T_L$ )	183°C	217°C
• Time ( $t_L$ )	60 to 150 seconds	60 to 150 seconds
Peak Temperature ( $T_P$ )	240°C + 0°C/-5°C	260°C + 0°C/-5°C
Time Within 5°C of Actual Peak Temperature ( $t_p$ )	10 to 30 seconds	20 to 40 seconds
Ramp-Down Rate	6°C/second max	
Time 25°C to Peak Temperature	6 minutes max	8 minutes max

Figure 2. Recommended Soldering Profile

# PIN CONFIGURATIONS AND FUNCTION DESCRIPTIONS

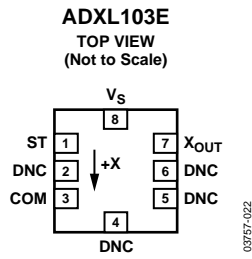

Figure 3. ADXL103 Pin Configuration

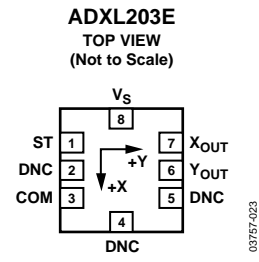

Figure 4. ADXL203 Pin Configuration

Table 4. ADXL103 Pin Function Descriptions

Pin No.	Mnemonic	Description
1	ST	Self Test
2	DNC	Do Not Connect
3	COM	Common
4	DNC	Do Not Connect
5	DNC	Do Not Connect
6	DNC	Do Not Connect
7	X <sub>OUT</sub>	X Channel Output
8	V <sub>S</sub>	3 V to 6 V

Table 5. ADXL203 Pin Function Descriptions

Pin No.	Mnemonic	Description
1	ST	Self Test
2	DNC	Do Not Connect
3	COM	Common
4	DNC	Do Not Connect
5	DNC	Do Not Connect
6	Y <sub>OUT</sub>	Y Channel Output
7	X <sub>OUT</sub>	X Channel Output
8	V <sub>S</sub>	3 V to 6 V

## TYPICAL PERFORMANCE CHARACTERISTICS

$V_s = 5\text{ V}$  for all graphs, unless otherwise noted.

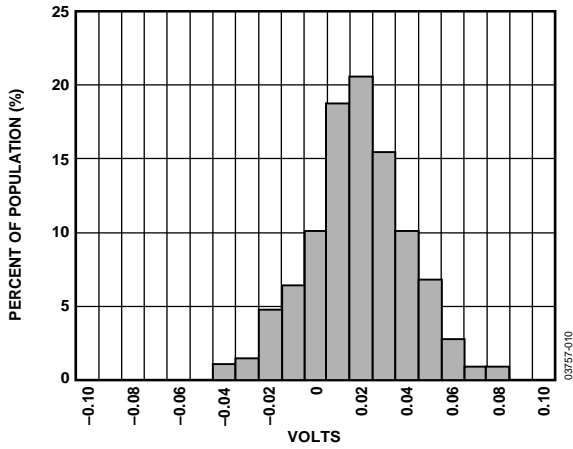

Figure 5. X-Axis Zero g Bias Deviation from Ideal at 25°C

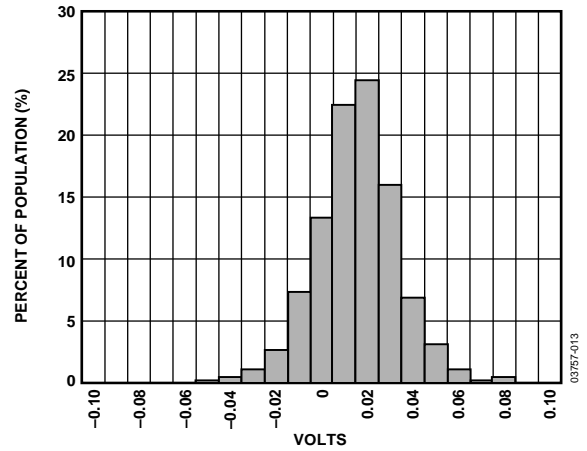

Figure 8. Y-Axis Zero g Bias Deviation from Ideal at 25°C

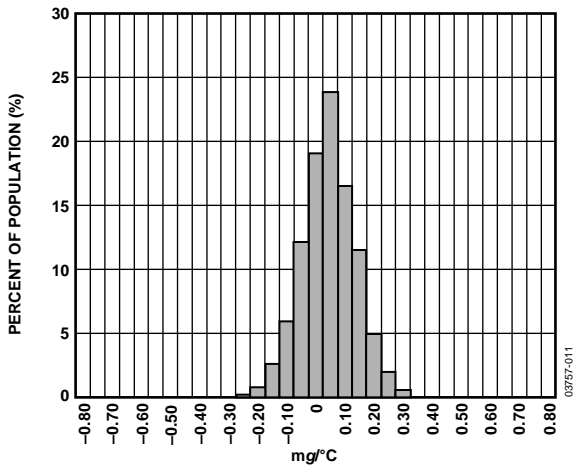

Figure 6. X-Axis Zero g Bias Tempco

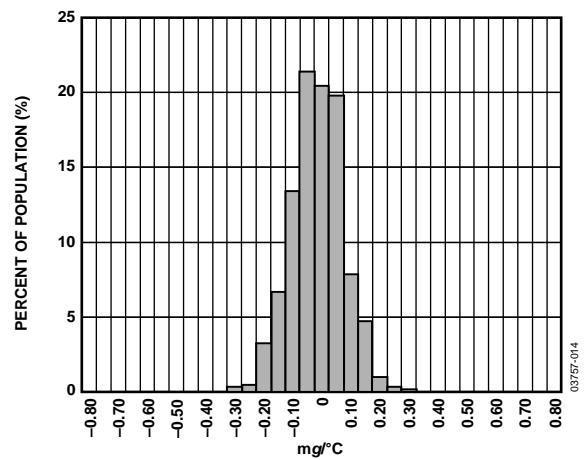

Figure 9. Y-Axis Zero g Bias Tempco

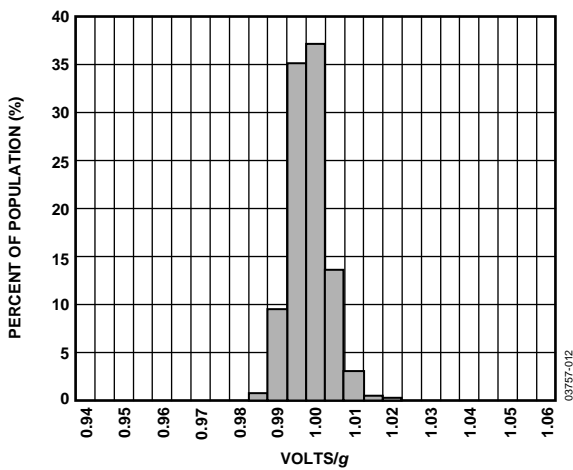

Figure 7. X-Axis Sensitivity at 25°C

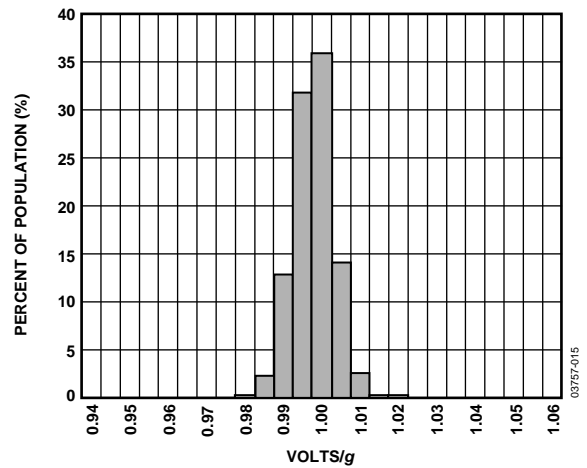

Figure 10. Y-Axis Sensitivity at 25°C

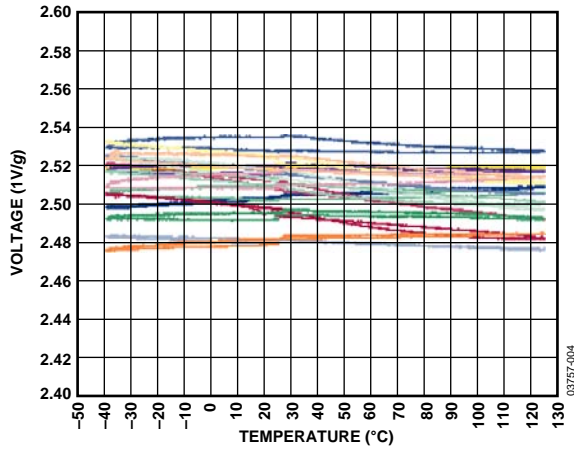

Figure 11. Zero g Bias vs. Temperature; Parts Soldered to PCB

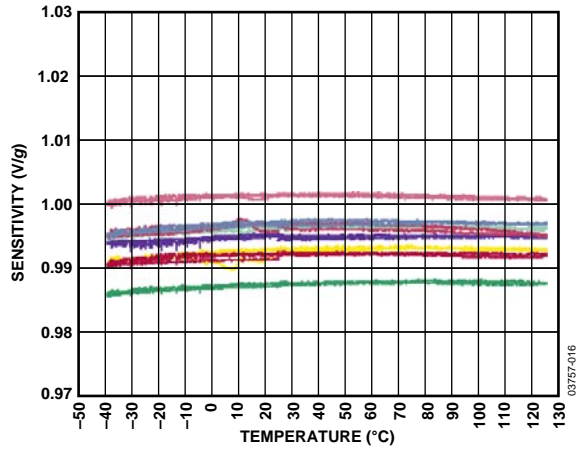

Figure 14. Sensitivity vs. Temperature; Parts Soldered to PCB

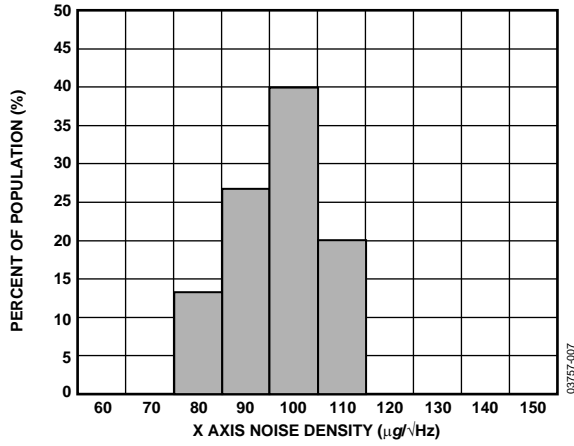

Figure 12. X-Axis Noise Density at 25°C

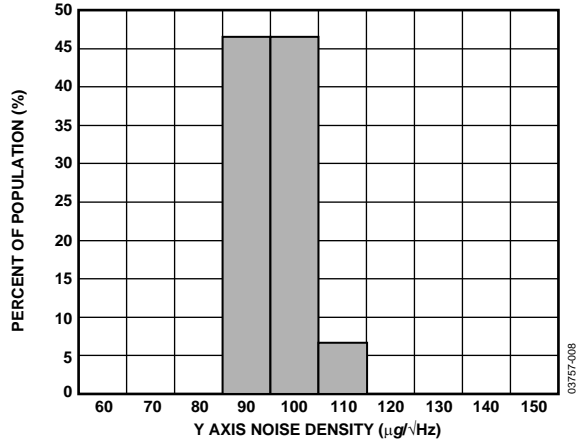

Figure 15. Y-Axis Noise Density at 25°C

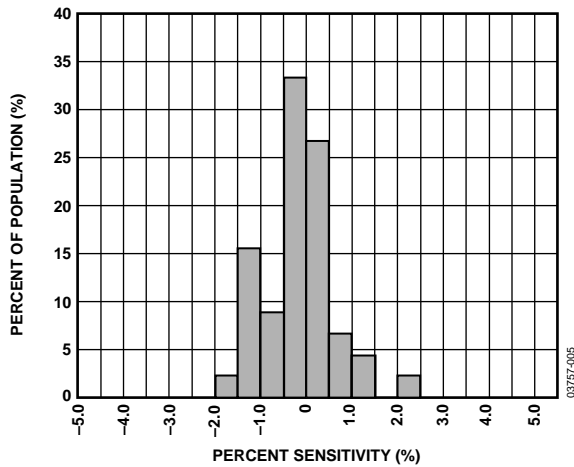

Figure 13. Z vs. X Cross-Axis Sensitivity

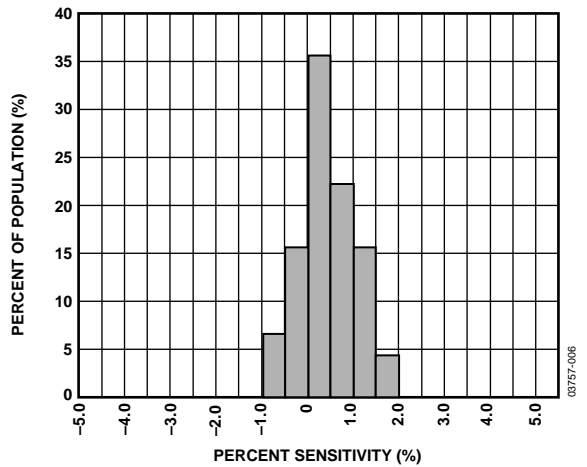

Figure 16. Z vs. Y Cross-Axis Sensitivity

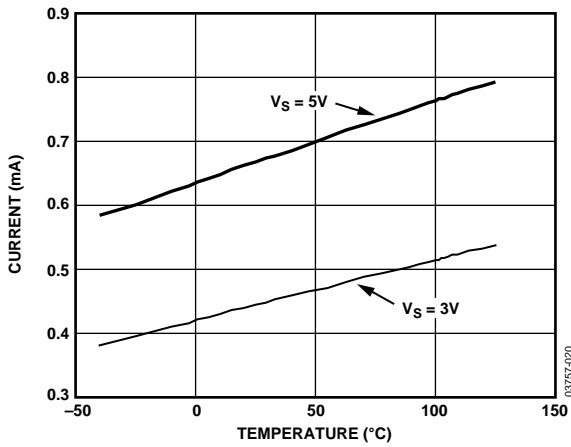

Figure 17. Supply Current vs. Temperature

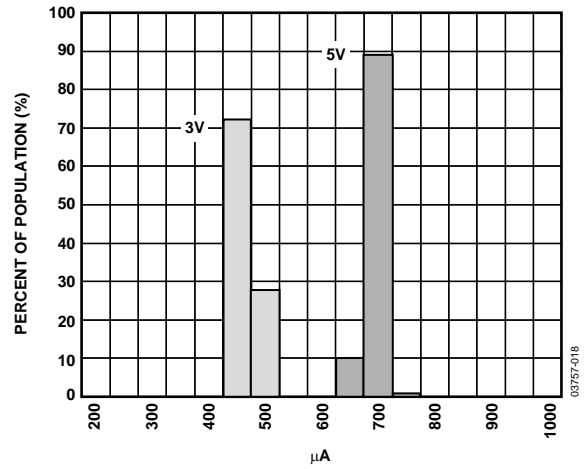

Figure 20. Supply Current at 25°C

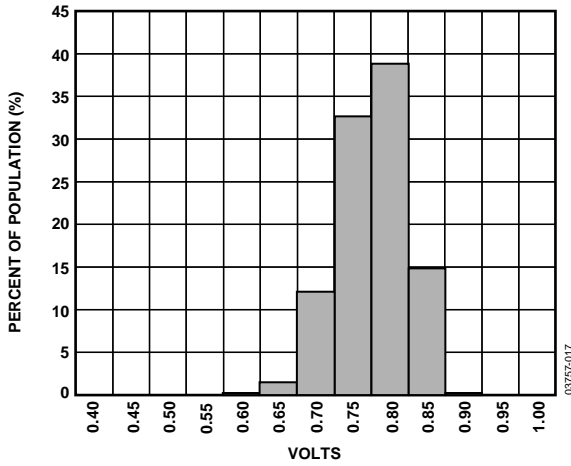

Figure 18. X-Axis Self-Test Response at 25°C

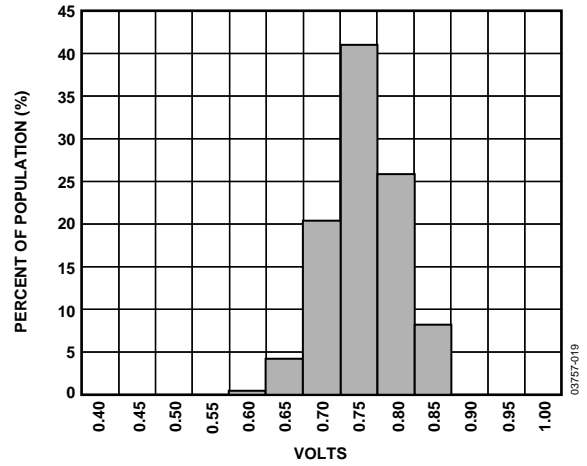

Figure 21. Y-Axis Self-Test Response at 25°C

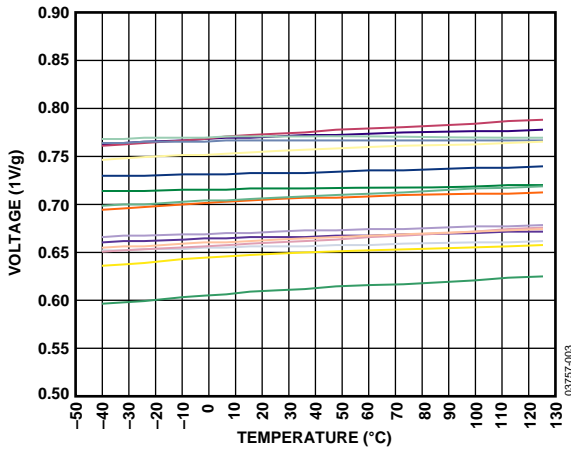

Figure 19. Self-Test Response vs. Temperature

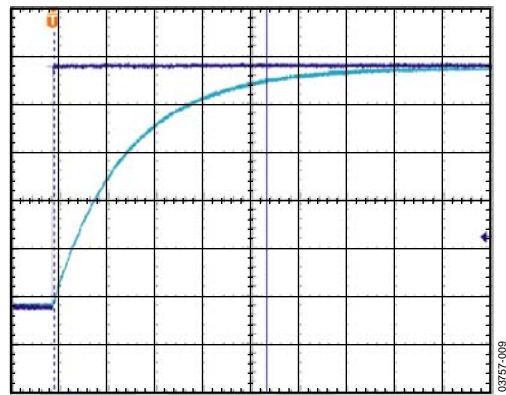

Figure 22. Turn-On Time –  $C_x, C_y = 0.1 \mu\text{F}$ , Time Scale = 2 ms/div



## THEORY OF OPERATION

The ADXL103/ADXL203 are complete acceleration measurement systems on a single, monolithic IC. The ADXL103 is a single-axis accelerometer, and the ADXL203 is a dual-axis accelerometer. Both parts contain a polysilicon surface-micromachined sensor and signal conditioning circuitry to implement an open-loop acceleration measurement architecture. The output signals are analog voltages proportional to acceleration. The ADXL103/ADXL203 are capable of measuring both positive and negative accelerations to at least  $\pm 1.7 g$ . The accelerometer can measure static acceleration forces such as gravity, allowing it to be used as a tilt sensor.

The sensor is a surface-micromachined polysilicon structure built on top of the silicon wafer. Polysilicon springs suspend the structure over the surface of the wafer and provide a resistance against acceleration forces. Deflection of the structure is measured using a differential capacitor that consists of independent fixed plates and plates attached to the moving mass. The fixed plates are driven by  $180^\circ$  out-of-phase square waves. Acceleration deflects the beam and unbalances the differential capacitor, resulting in an output square wave whose amplitude is proportional to acceleration. Phase-sensitive demodulation techniques are then used to rectify the signal and determine the direction of the acceleration.

The output of the demodulator is amplified and brought off-chip through a  $32 k\Omega$  resistor. At this point, the user can set the signal bandwidth of the device by adding a capacitor. This filtering improves measurement resolution and helps prevent aliasing.

## PERFORMANCE

Rather than using additional temperature compensation circuitry, innovative design techniques have been used to ensure that high performance is built in. As a result, there is essentially no quantization error or non-monotonic behavior, and temperature hysteresis is very low (typically less than  $10 mg$  over the  $-40^\circ C$  to  $+125^\circ C$  temperature range).

Figure 11 shows the  $0 g$  output performance of eight parts (x and y axes) over a  $-40^\circ C$  to  $+125^\circ C$  temperature range.

Figure 14 demonstrates the typical sensitivity shift over temperature for  $V_s = 5 V$ . Sensitivity stability is optimized for  $V_s = 5 V$  but is still very good over the specified range; it is typically better than  $\pm 1\%$  over temperature at  $V_s = 3 V$ .

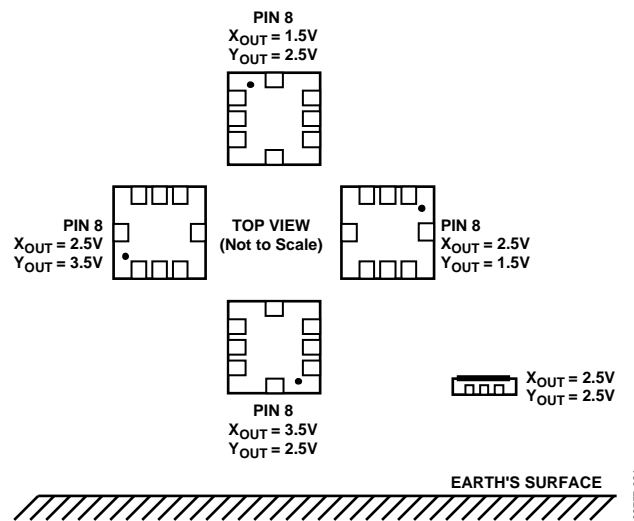

Figure 23. Output Response vs. Orientation

03/57-021

## APPLICATIONS

### POWER SUPPLY DECOUPLING

For most applications, a single 0.1  $\mu\text{F}$  capacitor,  $C_{\text{DC}}$ , adequately decouples the accelerometer from noise on the power supply. However in some cases, particularly where noise is present at the 140 kHz internal clock frequency (or any harmonic thereof), noise on the supply can cause interference on the ADXL103/ADXL203 output. If additional decoupling is needed, a 100  $\Omega$  (or smaller) resistor or ferrite beads can be inserted in the supply line of the ADXL103/ADXL203. Additionally, a larger bulk bypass capacitor (in the 1  $\mu\text{F}$  to 22  $\mu\text{F}$  range) can be added in parallel to  $C_{\text{DC}}$ .

### SETTING THE BANDWIDTH USING $C_X$ AND $C_Y$

The ADXL103/ADXL203 has provisions for band limiting the  $X_{\text{OUT}}$  and  $Y_{\text{OUT}}$  pins. Capacitors must be added at these pins to implement low-pass filtering for antialiasing and noise reduction. The equation for the 3 dB bandwidth is

$$F_{-3\text{dB}} = 1 / (2\pi(32\text{ k}\Omega) \times C_{(X, Y)})$$

or more simply,

$$F_{-3\text{dB}} = 5\ \mu\text{F} / C_{(X, Y)}$$

The tolerance of the internal resistor ( $R_{\text{FILT}}$ ) can vary typically as much as  $\pm 25\%$  of its nominal value (32 k $\Omega$ ); thus, the bandwidth varies accordingly. A minimum capacitance of 2000 pF for  $C_X$  and  $C_Y$  is required in all cases.

**Table 6. Filter Capacitor Selection,  $C_X$  and  $C_Y$**

Bandwidth (Hz)	Capacitor ( $\mu\text{F}$ )
1	4.7
10	0.47
50	0.10
100	0.05
200	0.027
500	0.01

### SELF TEST

The ST pin controls the self-test feature. When this pin is set to  $V_S$ , an electrostatic force is exerted on the beam of the accelerometer. The resulting movement of the beam allows the user to test if the accelerometer is functional. The typical change in output is 750 mg (corresponding to 750 mV). This pin can be left open-circuit or connected to common in normal use.

The ST pin should never be exposed to voltage greater than  $V_S + 0.3\text{ V}$ . If the system design is such that this condition cannot be guaranteed (that is, multiple supply voltages are present), a low  $V_F$  clamping diode between ST and  $V_S$  is recommended.

### DESIGN TRADE-OFFS FOR SELECTING FILTER CHARACTERISTICS: THE NOISE/BW TRADE-OFF

The accelerometer bandwidth selected ultimately determines the measurement resolution (smallest detectable acceleration). Filtering can be used to lower the noise floor, improving the resolution of the accelerometer. Resolution is dependent on the analog filter bandwidth at  $X_{\text{OUT}}$  and  $Y_{\text{OUT}}$ .

The output of the ADXL103/ADXL203 has a typical bandwidth of 2.5 kHz. The user must filter the signal at this point to limit aliasing errors. The analog bandwidth must be no more than half the analog-to-digital sampling frequency to minimize aliasing. The analog bandwidth can be further decreased to reduce noise and improve resolution.

The ADXL103/ADXL203 noise has the characteristics of white Gaussian noise, which contributes equally at all frequencies and is described in terms of  $\mu\text{g}/\sqrt{\text{Hz}}$  (that is, the noise is proportional to the square root of the accelerometer bandwidth). The user should limit bandwidth to the lowest frequency needed by the application to maximize the resolution and dynamic range of the accelerometer.

With the single pole roll-off characteristic, the typical noise of the ADXL103/ADXL203 is determined by

$$\text{rmsNoise} = (110\ \mu\text{g}/\sqrt{\text{Hz}}) \times (\sqrt{\text{BW} \times 1.6})$$

At 100 Hz, the noise is

$$\text{rmsNoise} = (110\ \mu\text{g}/\sqrt{\text{Hz}}) \times (\sqrt{100 \times 1.6}) = 1.4\ \text{mg}$$

Often, the peak value of the noise is desired. Peak-to-peak noise can only be estimated by statistical methods. Table 7 is useful for estimating the probabilities of exceeding various peak values, given the rms value.

**Table 7. Estimation of Peak-to-Peak Noise**

Peak-to-Peak Value	% of Time That Noise Exceeds Nominal Peak-to-Peak Value
2 $\times$ rms	32
4 $\times$ rms	4.6
6 $\times$ rms	0.27
8 $\times$ rms	0.006

Peak-to-peak noise values give the best estimate of the uncertainty in a single measurement; peak-to-peak noise is estimated by  $6 \times$  rms. Table 8 gives the typical noise output of the ADXL103/ADXL203 for various  $C_x$  and  $C_y$  values.

**Table 8. Filter Capacitor Selection ( $C_x$ ,  $C_y$ )**

Bandwidth (Hz)	$C_x$ , $C_y$ ( $\mu\text{F}$ )	RMS Noise (mg)	Peak-to-Peak Noise Estimate (mg)
10	0.47	0.4	2.6
50	0.1	1.0	6
100	0.047	1.4	8.4
500	0.01	3.1	18.7

### USING THE ADXL103/ADXL203 WITH OPERATING VOLTAGES OTHER THAN 5 V

The ADXL103/ADXL203 is tested and specified at  $V_s = 5$  V; however, it can be powered with  $V_s$  as low as 3 V or as high as 6 V. Some performance parameters change as the supply voltage is varied.

The ADXL103/ADXL203 output is ratiometric, so the output sensitivity (or scale factor) varies proportionally to supply voltage. At  $V_s = 3$  V the output sensitivity is typically 560 mV/g.

The zero g bias output is also ratiometric, so the zero g output is nominally equal to  $V_s/2$  at all supply voltages.

The output noise is not ratiometric but is absolute in volts; therefore, the noise density decreases as the supply voltage increases. This is because the scale factor (mV/g) increases while the noise voltage remains constant. At  $V_s = 3$  V, the noise density is typically 190  $\mu\text{g}/\sqrt{\text{Hz}}$ .

Self-test response in g is roughly proportional to the square of the supply voltage. However, when ratiometricity of sensitivity is factored in with supply voltage, self-test response in volts is roughly proportional to the cube of the supply voltage. So at  $V_s = 3$  V, the self-test response is approximately equivalent to 150 mV or equivalent to 270 mg (typical).

The supply current decreases as the supply voltage decreases. Typical current consumption at  $V_{DD} = 3$  V is 450  $\mu\text{A}$ .

### USING THE ADXL203 AS A DUAL-AXIS TILT SENSOR

One of the most popular applications of the ADXL203 is tilt measurement. An accelerometer uses the force of gravity as an input vector to determine the orientation of an object in space.

An accelerometer is most sensitive to tilt when its sensitive axis is perpendicular to the force of gravity, that is, parallel to the earth's surface. At this orientation, its sensitivity to changes in tilt is highest. When the accelerometer is oriented on axis to gravity, that is, near its +1 g or -1 g reading, the change in output acceleration per degree of tilt is negligible. When the accelerometer is perpendicular to gravity, its output changes nearly 17.5 mg per degree of tilt. At 45°, its output changes at only 12.2 mg per degree, and resolution declines.

#### Dual-Axis Tilt Sensor: Converting Acceleration to Tilt

When the accelerometer is oriented so both its x axis and y axis are parallel to the earth's surface, it can be used as a 2-axis tilt sensor with a roll axis and a pitch axis. Once the output signal from the accelerometer has been converted to an acceleration that varies between -1 g and +1 g, the output tilt in degrees is calculated as follows:

$$PITCH = ASIN(A_x/1 g)$$

$$ROLL = ASIN(A_y/1 g)$$

Be sure to account for overranges. It is possible for the accelerometers to output a signal greater than  $\pm 1$  g due to vibration, shock, or other accelerations.

# ADXL103/ADXL203

## OUTLINE DIMENSIONS

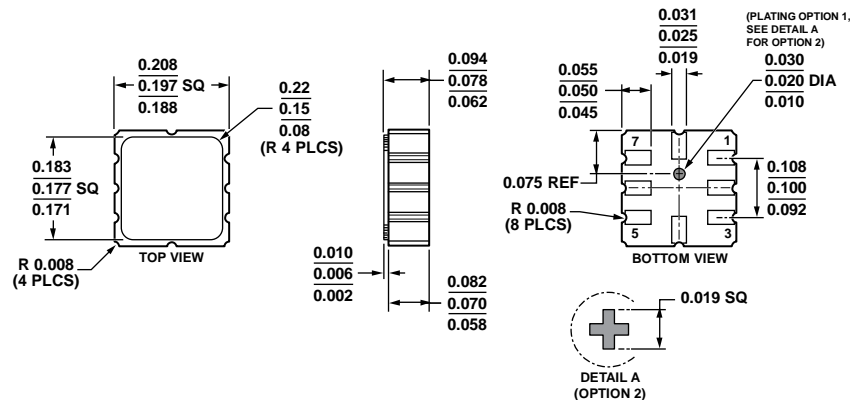

Figure 24. 8-Terminal Ceramic Leadless Chip Carrier [LCC]  
(E-8-1)  
Dimensions shown in inches

## ORDERING GUIDE

Model <sup>1,2</sup>	Number of Axes	Specified Voltage (V)	Temperature Range	Package Description	Package Option
ADXL103CE	1	5	-40°C to +125°C	8-Terminal Ceramic LCC <sup>3</sup>	E-8-1
ADXL103CE-REEL	1	5	-40°C to +125°C	8-Terminal Ceramic LCC <sup>3</sup>	E-8-1
ADXL103WCEZB	1	5	-40°C to +125°C	8-Terminal Ceramic LCC	E-8-1
ADXL103WCEZB-REEL	1	5	-40°C to +125°C	8-Terminal Ceramic LCC	E-8-1
ADXL203CE	2	5	-40°C to +125°C	8-Terminal Ceramic LCC <sup>3</sup>	E-8-1
ADXL203CE-REEL	2	5	-40°C to +125°C	8-Terminal Ceramic LCC <sup>3</sup>	E-8-1
ADXL203WCEZB	2	5	-40°C to +125°C	8-Terminal Ceramic LCC	E-8-1
ADXL203WCEZB-REEL	2	5	-40°C to +125°C	8-Terminal Ceramic LCC	E-8-1
ADXL203EB				Evaluation Board	

<sup>1</sup> Z = RoHS Compliant Part.

<sup>2</sup> W = Qualified for Automotive Applications.

<sup>3</sup> Lead finish. Gold over nickel over tungsten.

## AUTOMOTIVE PRODUCTS

The ADXL103W and ADXL203W models are available with controlled manufacturing to support the quality and reliability requirements of automotive applications. Note that these automotive models may have specifications that differ from the commercial models; therefore, designers should review the Specifications section of this data sheet carefully. Only the automotive grade products shown are available for use in automotive applications. Contact your local Analog Devices account representative for specific product ordering information and to obtain the specific Automotive Reliability reports for these models.